

# NEW PRODUCT FLONDER

VIAPLANT 2025



*The FLONDER lamp combines simplicity in form with a connection to nature.*

With its sleek cylindrical shape and unique plant patterns, its light transcends mere functionality. Whether as a table lamp or a ceiling fixture, every element of the Flonder lamp reflects attention to detail and timeless elegance.

*This is just the beginning – the collection will soon expand with new pieces, bringing even more light and a nature-inspired experience into our homes.*



VIAPLANT

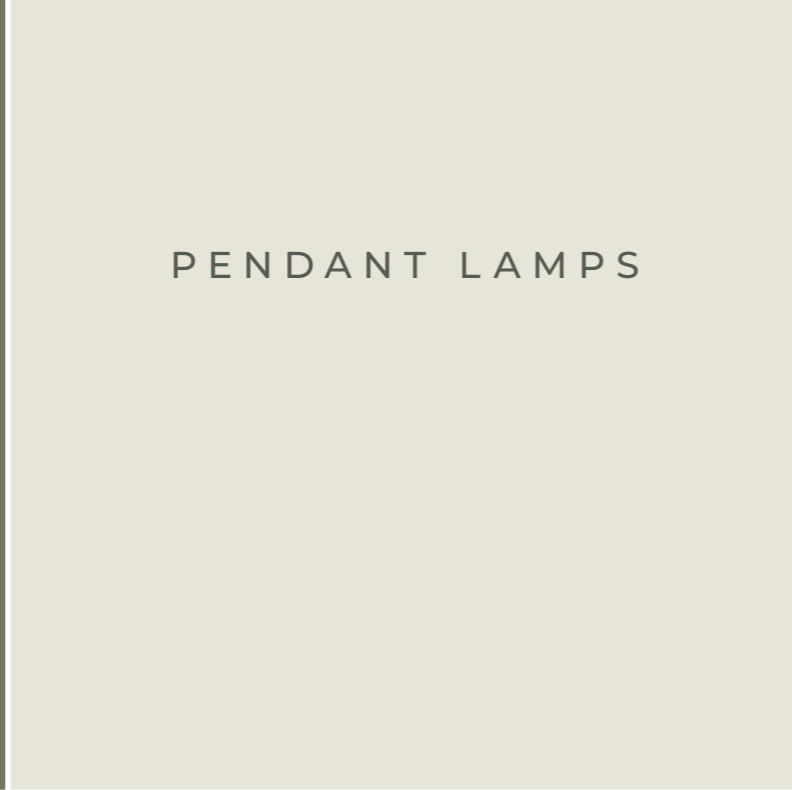

PENDANT LAMPS



FUTURE PRODUCTS



BEDSIDE TABLE LAMP

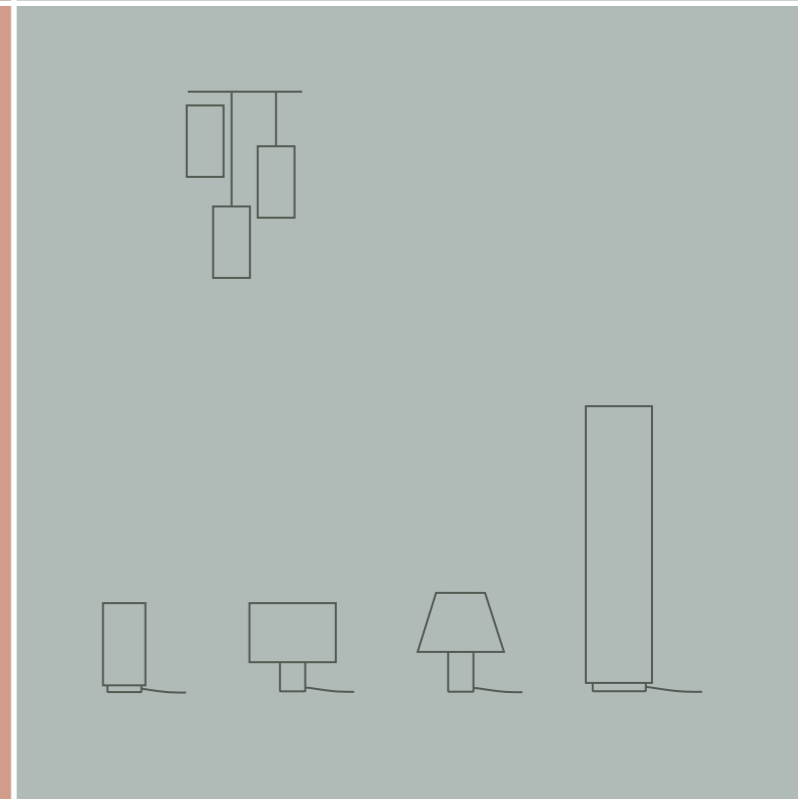

# FLONDER

BEDSIDE TABLE LAMP

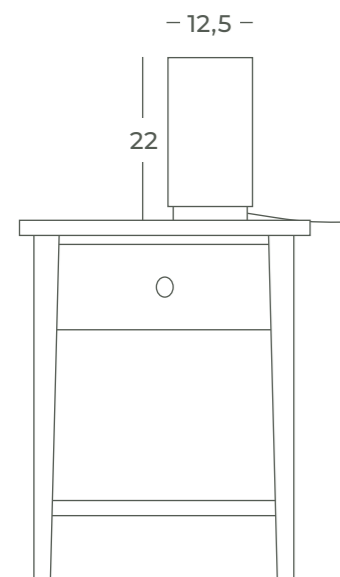

## MODELS

7001 - wooden base, in-line switch on cord

## LIGHT SOURCE

E27 LED light

## DIMENSIONS

HEIGHT 22cm  
DIAMETER 12,5  
CORD LENGTH 2m

## WEIGHT

NET 0,5 kg  
GROSS 1 kg

## MATERIALS

BASE: ASH WOOD  
SHADE: Viaplant® TEXTILE





# FLONDER

PENDANT LAMP

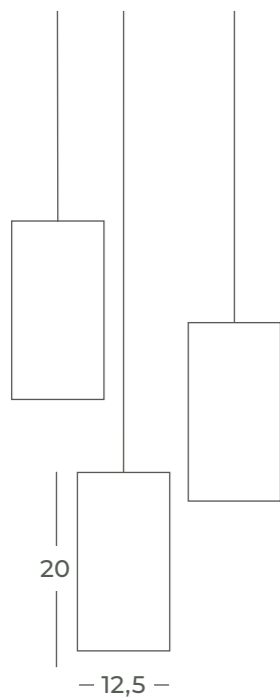

## MODELS

7001 - wooden base, in-line switch on cord

## LIGHT SOURCE

E27 LED light

## DIMENSIONS

HEIGHT 22cm  
DIAMETER 12,5  
CORD LENGTH 2m

## WEIGHT

NET 0,5 kg  
GROSS 1 kg

## MATERIALS

BASE: ASH WOOD  
SHADE: Viaplant® TEXTILE





2025

VIAPLANT

*TIMELESS BEAUTY*



## *PLANT VARIATIONS*

An obvious feature of Viaplant is the plant itself. Like amber that captures the history of life Viaplant encapsulates nature's artistic performance. It preserves the details, colors and texture of the plants, creating a unique and inimitable pattern for each piece.







### LUNARIA | annua honesty

The delicate beauty of the honesty plant's translucent seed pods exudes a fragile elegance. The dry, silvery husks hang gracefully from the slender stem, resembling tiny works of art. This natural composition evokes both abstract artistic creations and fine craftsmanship.



### **COTINUS | smoke bush**

The ethereal beauty of the Cotinus, or smoke bush, lies in its misty plumes, which float above the leaves like soft clouds. These delicate, airy blooms and bold foliage create a natural masterpiece, blending dreamy elegance with vibrant seasonal color, as if crafted by nature's own brush.



### **ELEAGNA | silver berry**

The *Eleagnus angustifolia*, or silverberry, is an invasive tree that outcompetes native plants. Through upcycling, we transform this fast-growing species into refined materials. Its silvery leaves and delicate texture add unique, organic beauty, turning a challenge into sustainable artistry.



### **FOLI CUVÉE | autumn leaves**

The fleeting beauty of autumn leaves is like fine wine, each year offering a unique palette. Fiery reds, burnt oranges, and golden yellows deepen as the season unfolds. Crafted into lamps, these leaves capture vibrant moments, imbuing each piece with timeless elegance and artistry.



Flores mix | mixed petals

Bespoke textures  
*Storytelling concept*

***A good object is defined by your understanding of what it means to you.***

The Viaplant brand is fundamentally defined by its philosophy, the so-called story concept. The duality of form and function is complemented by a story that stems from the place of origin of the plants and the associated memories.

A NEW PRODUCT  
LINE AWAITS.

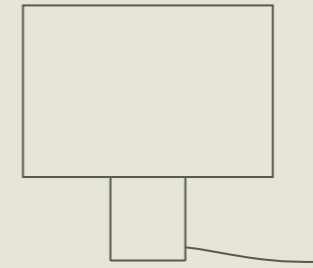
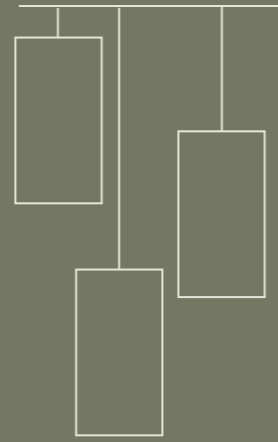

FUTURE PRODUCTS

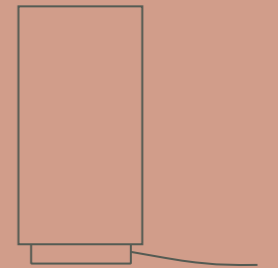

VIA PLANT

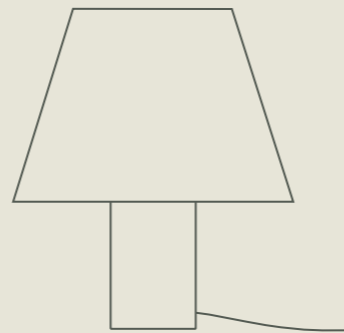

CREATE YOUR OWN LAMP  
TAILORED TO YOUR DESIRED SIZE.

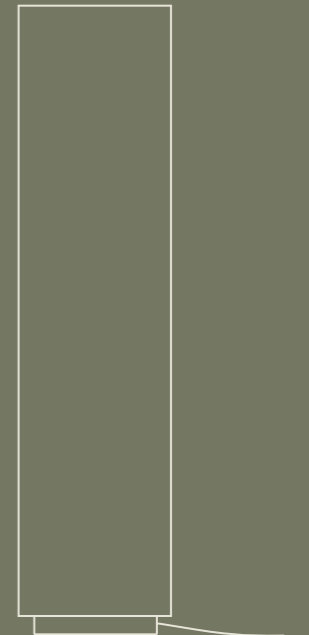



V I A P L A N T

## ***CONTACT US***

**+36 (20) 257 7040**

**[viaplant@viaplant.com](mailto:viaplant@viaplant.com)**

**[www.viaplant.com](http://www.viaplant.com)**

SHOWROOM

**1136 Budapest,  
Hegedűs Gyula utca 15.**